

Wall mounted unit  
Air Conditioning  
Technical Data  
FTXC-D



FTXC20DV1B  
FTXC25DV1B  
FTXC35DV1B  
FTXC50DV1B  
FTXC60DV1B  
FTXC71DV1B



# TABLE OF CONTENTS

# FTXC-D

---

1	Features	4
	FTXC-D	4
2	Specifications	5
3	Dimensional drawings	7
4	Piping diagrams	9
5	Wiring diagrams	11
	Wiring Diagrams - Three Phase	11
6	Sound data	12
	Sound Pressure Spectrum	12

# 1 Features

















## 1 - 1 FTXC-D

Wall mounted unit, offering good value for money

1

- › Flat, stylish front panel blends easily within any interior décor and is easier to clean
- › Onecta app (optional): control your indoor from any location with an app, via your local network or internet.
- › Seasonal efficiency values up to A++ in cooling
- › Choosing for an R-32 product, reduces the environmental impact with 68% compared to R-410A and leads directly to lower energy consumption thanks to its high energy efficiency



- |  |  |   |  |  |  |  |   |  |
|--|--|---|--|--|--|--|---|--|
| <br>Onecta app (optional) | <br>Energy saving during standby mode   | <br>Fan only   | <br>Powerful mode | <br>Auto cooling-heating changeover | <br>Comfortable sleeping mode | <br>Vertical auto swing | <br>Auto fan speed | <br>Fan speed steps (3 steps) |
| <br>Dry programme         | <br>Titanium apatite deodorising filter | <br>Air filter | <br>24 hour timer | <br>Infrared remote control         | <br>Auto-restart              | <br>Self diagnosis      |   |  |

## 2 Specifications

### 2 - 1 Specifications

Technical specifications				FTXC20D	FTXC25D	FTXC35D	FTXC50D	FTXC60D	FTXC71D		
Power input	Cooling	Nom.	kW	0.595	0.765	1.05	1.55	1.89	2.38		
	Heating	Nom.	kW	0.670	0.750	1.07	1.52	1.68	2.46		
Casing	Colour	White									
	Material	High impact polystyrene									
Dimensions	Unit	Height	mm	288				297			
		Width	mm	770				990			
		Depth	mm	234				273			
	Packed unit	Height	mm	327				371			
		Width	mm	830				1,073			
		Depth	mm	363				375			
Weight	Unit	kg	9.00		9.50		13.0				
	Packed unit	kg	11		12		16				
Packing	Material	EPS-Foam / Corrugated board									
	Weight	kg	2				3				
Heat exchanger	Length	mm	610				820				
	Rows	Quantity	2				1				
	Fin pitch	mm	1.41				1.41				
	Face area	m <sup>2</sup>	0.210		0.210		0.280				
	Stages	Quantity	18				18				
	Tube type	ø5 Hi-XB									
	Tube material	Copper									
	Tube diameter	mm	5								
	Fin	Type	Multi slit fin								
		Treatment	Hydrophilic								
Heat exchanger 2	Quantity	-				1		1			
	Length	mm	-				600		810		
	Rows	Quantity	-				1		1		
	Fin pitch	mm	-				1.41		1.41		
	Face area	m <sup>2</sup>	-				0.090		0.190		
	Stages	Quantity	-				8		12		
Fan	Type	Cross flow fan									
	Quantity	1									
Fan	Air flow rate	Cooling	High	m <sup>3</sup> /min	10.8	11.1	12.5	20.4			
			Medium	cfm	380	390	440	720			
	Low	m <sup>3</sup> /min	8.1	8.7	9.9	14.5					
		cfm	285	305	350	510					
Fan	Air flow rate	Cooling	Low	m <sup>3</sup> /min	6.1	6.4	8.1	12.5			
			cfm	215	225	285	440				
	Silent operation	m <sup>3</sup> /min	5.4		7.4		10.2				
		cfm	190		260		360				
Fan motor	Quantity	1									
	Model	DIC38S8P11									
	Type	DC motor									
	Index of Protection	40									
	Insulation grade	Class "E"									
	Poles	8									
	Drive	Direct drive									
	Speed	Steps	3 steps, turbo, quiet, auto								
	Cooling	High	rpm	1,080.000		1,120.000		1,220.000		1,200.000	
			Medium	850		900		1,000		900	
Low			680		710		850		800		
Silent operation			600		620		790		690		
Output	Rated	W									
Full load amps (FLA)	Cooling	A	0.15		0.16		0.20		0.45		
	Heating	A	0.15		0.16		0.20		0.45		
Sound power level	Cooling	High	dB(A)	57		58		60		63	
		Medium	dB(A)	40		41		47		48	
		Low	dB(A)	33		34		39		42	
		Silent operation	dB(A)	26		26		33		38	
	Silent operation	dB(A)	21		22		30		31		
Piping connections	Liquid	Type	Flare connection								
		OD	mm	6.35							
	Gas	Type	Flare connection								
		OD	mm	9.52				12.7			
Drain	16.5										
Heat insulation	Both liquid and gas pipes										
Air filter	Type	Removable / washable									
	Quantity	pc	2								
Air direction control	Left, right, up and downwards										
Temperature control	Microcomputer control										
Control systems	Infrared remote control	ARC486A2									

## 2 Specifications

### 2 - 1 Specifications

2

Electrical specifications				FTXC20D	FTXC25D	FTXC35D	FTXC50D	FTXC60D	FTXC71D
Power supply	Name			V1					
	Phase			1~					
	Frequency			50					
	Voltage			220-240					
Current	Nominal running current (RLA) - 50Hz	Heating	A	2.73	3.02	4.34	5.97	6.31	9.38
	Maximum fuse amps (MFA)			16					
Power supply intake				Outdoor unit only					
Current	Nominal running current (RLA)	Cooling	A	3.00	3.04	4.20	6.24	7.22	8.98

### 3 Dimensional drawings

#### 3 - 1 Dimensional Drawings

ATXC20-50D  
FTXC20-50D

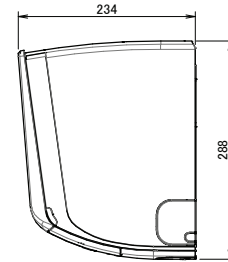
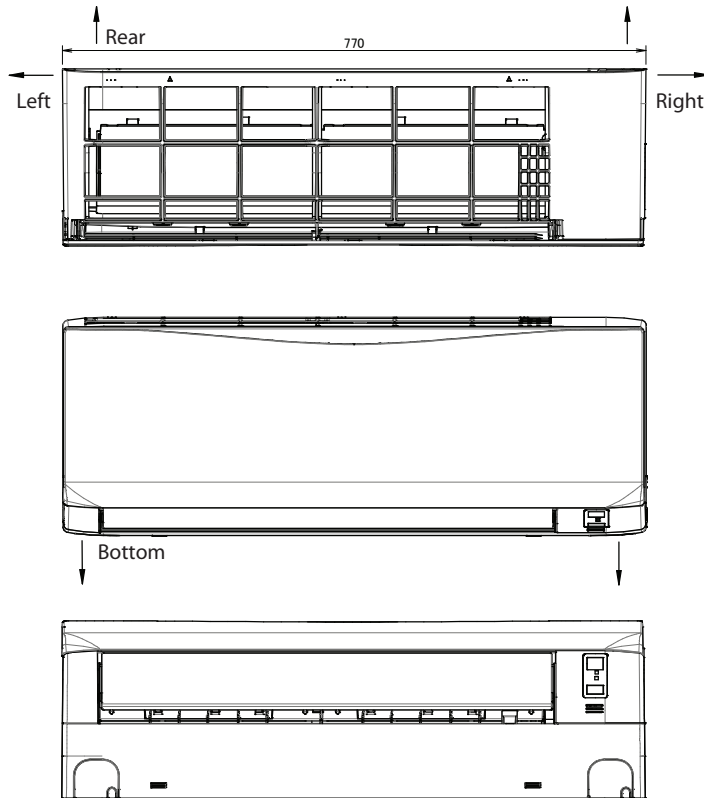

3D139495A

ATXC20-50D  
FTXC20-50D

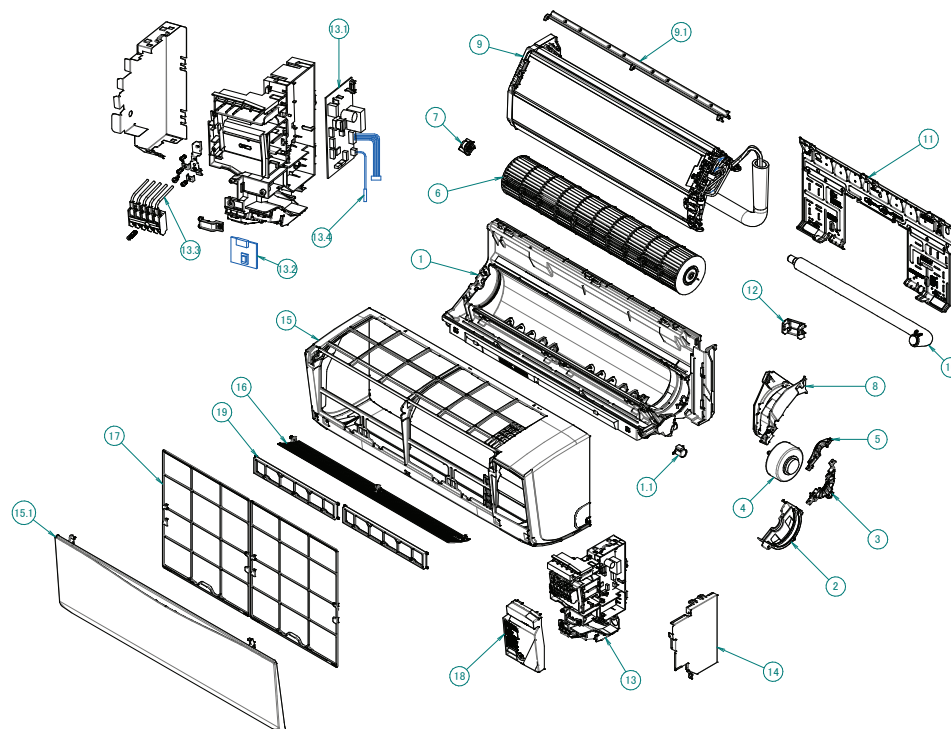

No	Description
1	Bottom frame assy
1.1	Stepping motor
2	Motor mounting plate (1)
3	Motor mounting plate (2)
4	Fan motor (DC)
5	Motor mounting plate (3)
6	Cross flow fan assy
7	Fan bearing vibration absorber assy (M)
8	Right side panel (resin)
9	Heat exchanger assy
9.1	Sealing plate (top)
10	Drain hose assy
11	Installation plate assy
12	Piping fixture
13	El. compo. assy (DC)
13.1	Control module
13.2	IR receiver board
13.3	Assy. harness wire
13.4	Indoor coil sensor
14	Shield plate (2)
15	Front grille
15.1	Front panel
16	Disch. grille hor. blade assy
17	Air filter
18	Service cover assy
19	Air filter assy titanium apatite

3D141728A

### 3 Dimensional drawings

#### 3 - 1 Dimensional Drawings

3

ATXC60-71D  
FTXC60-71D

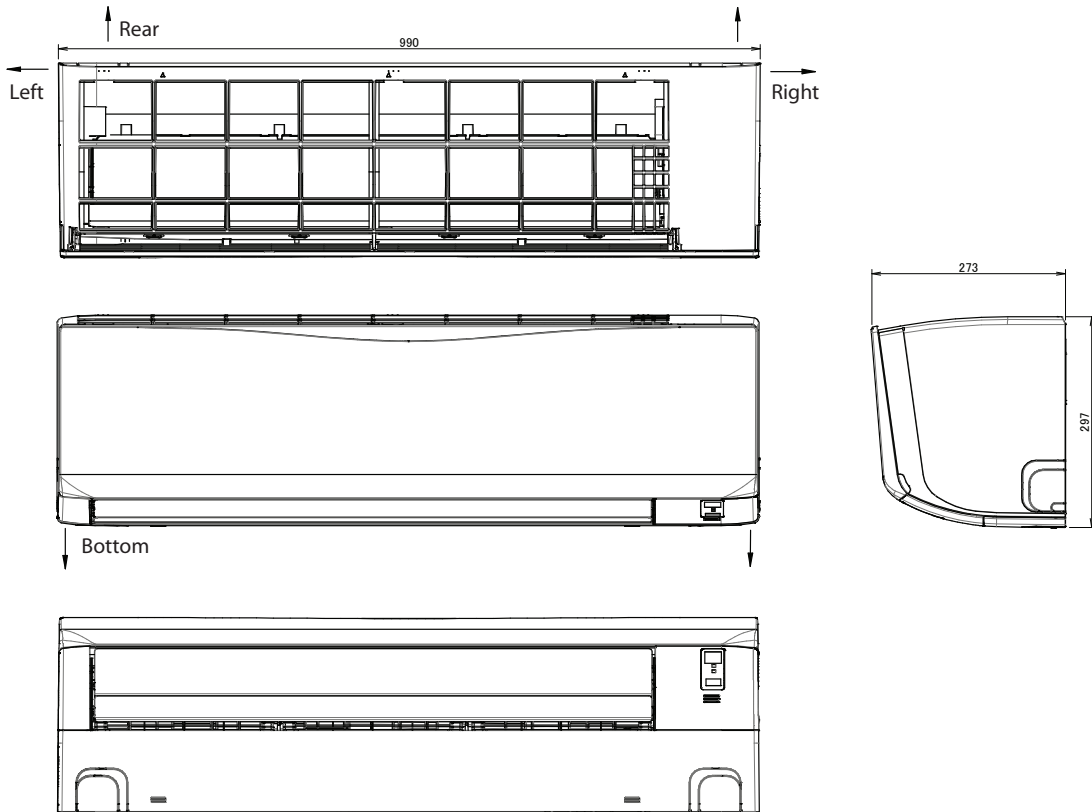

3D139496A

ATXC60-71D  
FTXC60-71D

No	Description
1	Bottom frame assy
2	Drain pan assy
2.1	Stepping motor
3	Motor mounting plate (1)
4	Motor mounting plate (2)
5	Fan motor
6	Motor mounting plate (3)
7	Cross flow fan assy
8	Fan bearing vibration absorber assy
9	Right side panel (resin)
10	Heat exchanger assy
10.1	Sealing plate (top)
11	Drain hose assy
12	Installation plate assy
13	Piping fixture
14	El. Compo assy
14.1	PCB assy (main)
14.2	Indication lamp cover
14.3	Terminal block
14.4	Wire harness assy
14.5	Shield plate (1)
14.6	Earth clamp
14.7	Wire clamp
14.8	El compo box
14.9	Indoor coil sensor
14.10	PCB assy (display board)
15	Shield plate (2)
16	Front grille
16.1	Front panel
17	Disch grille hori blade assy
18	Air filter
19	Service cover assy
20	Air filter assy titanium apatite

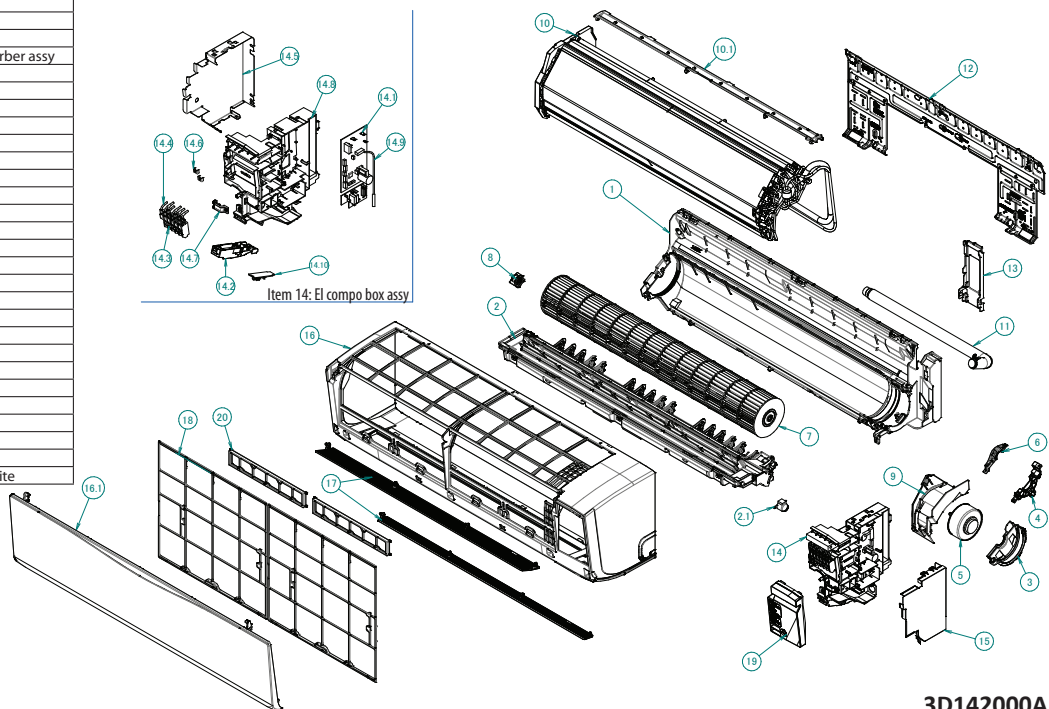

3D142000A



# 4 Piping diagrams

## 4 - 1 Piping Diagrams

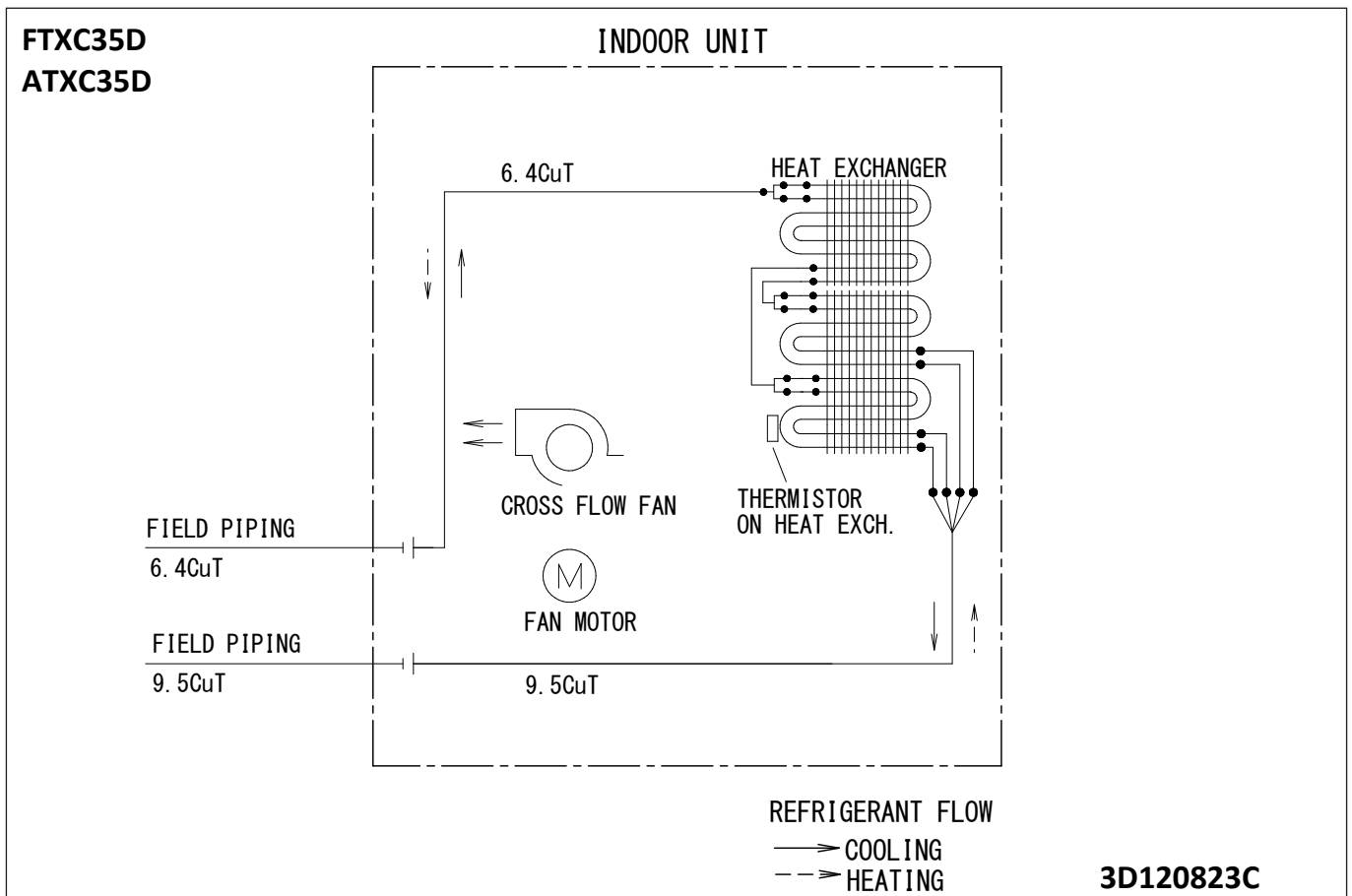
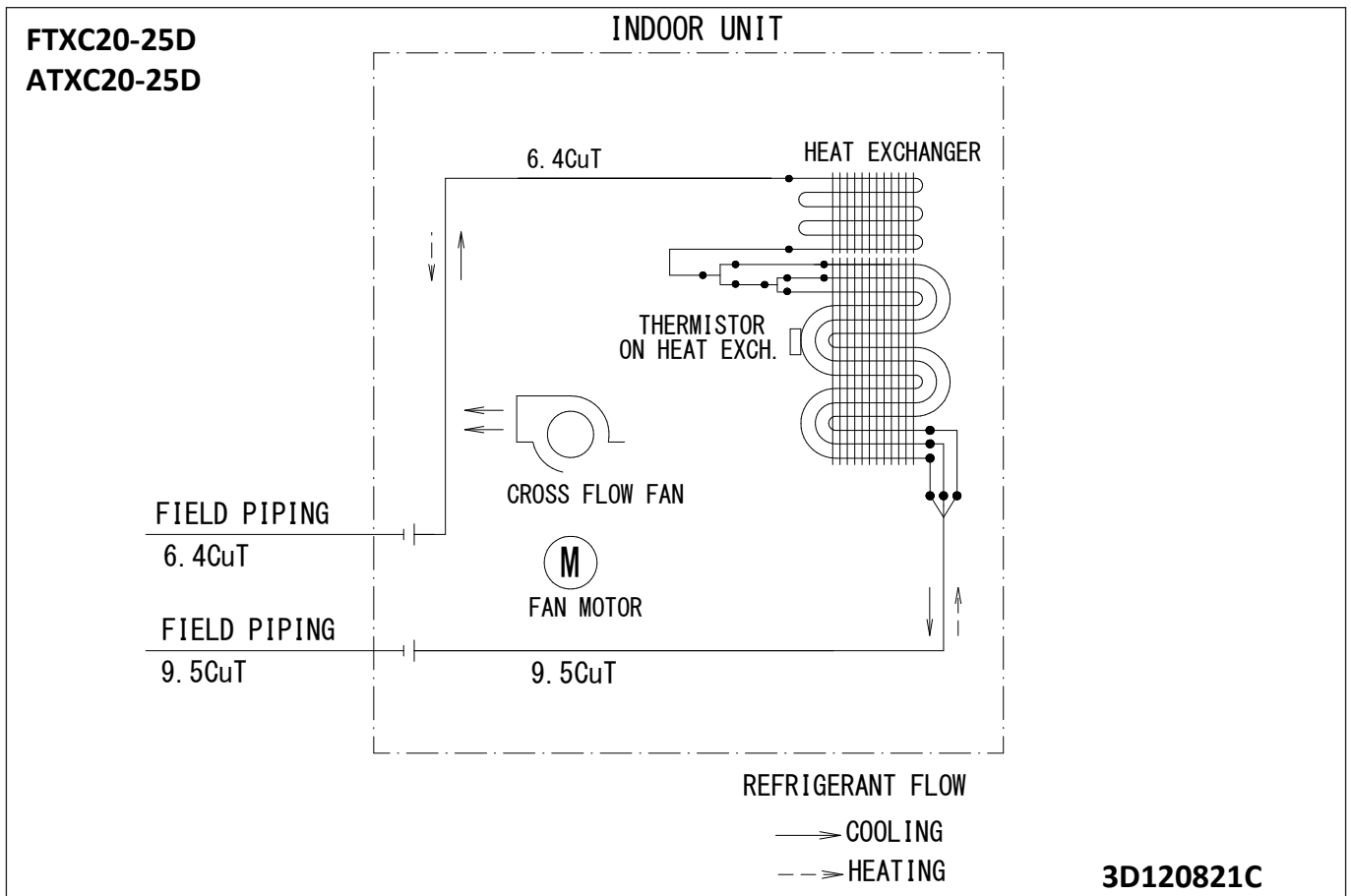

# 4 Piping diagrams

## 4 - 1 Piping Diagrams

4

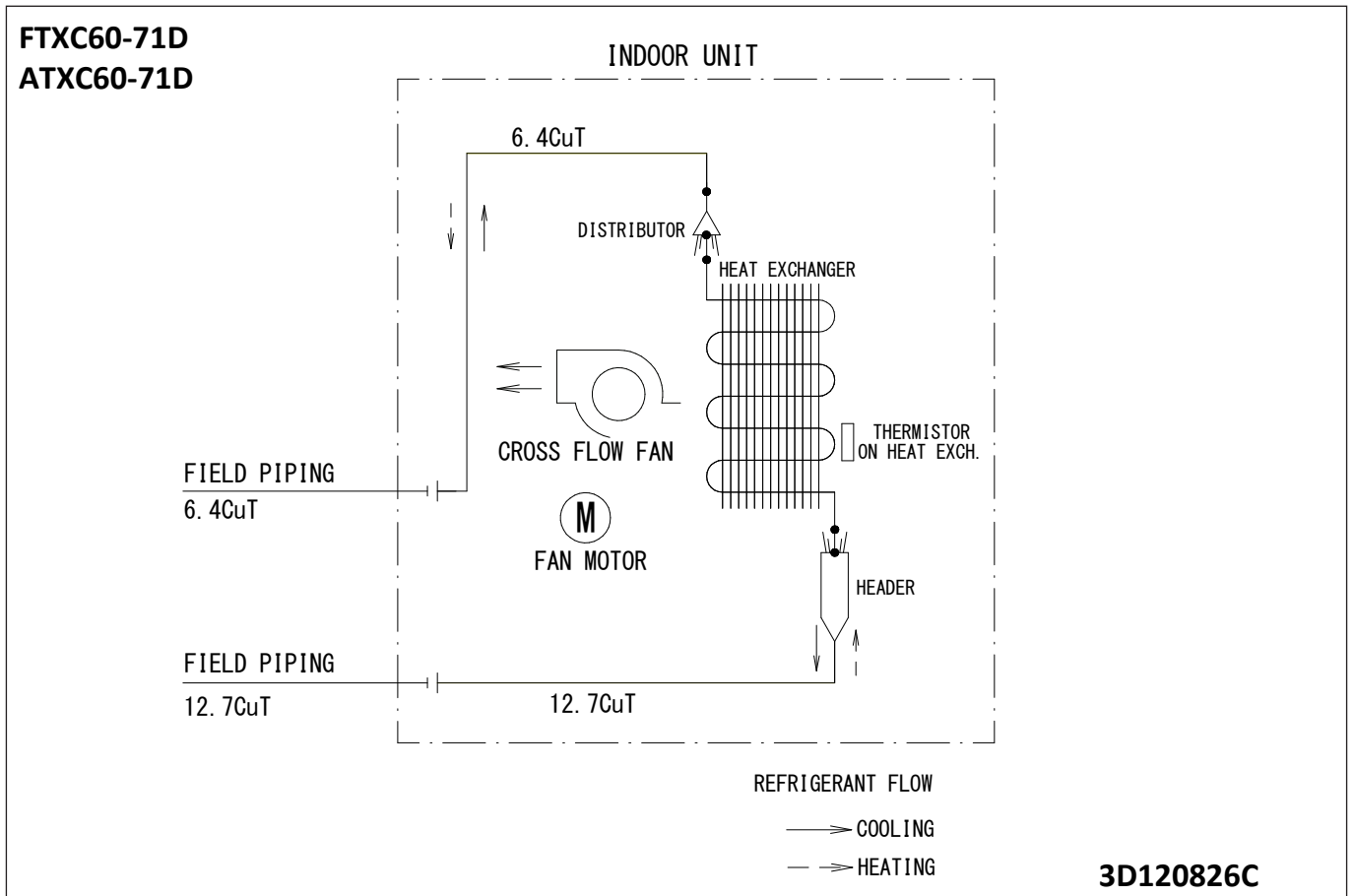
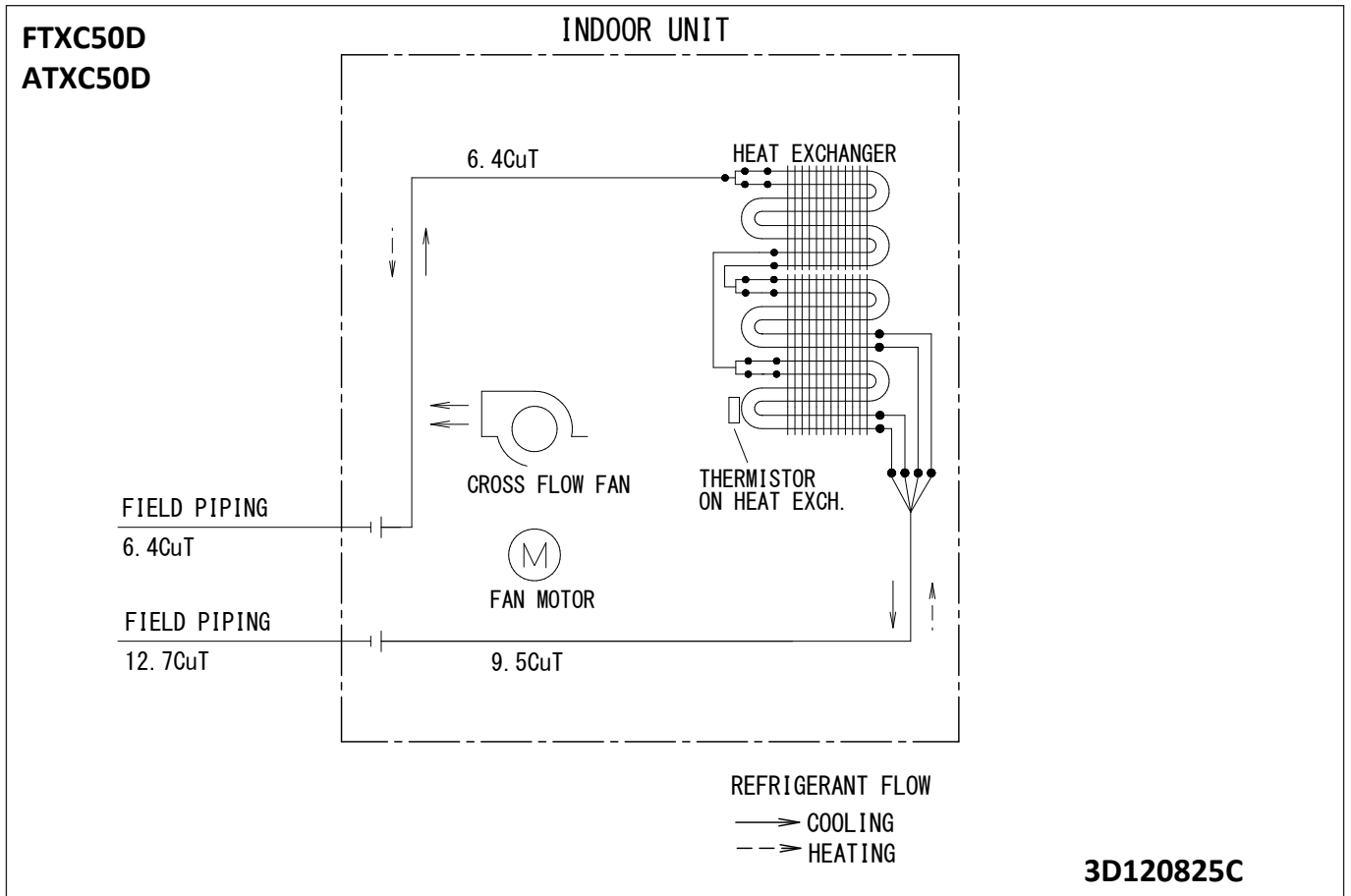

# 5 Wiring diagrams

## 5 - 1 Wiring Diagrams - Three Phase

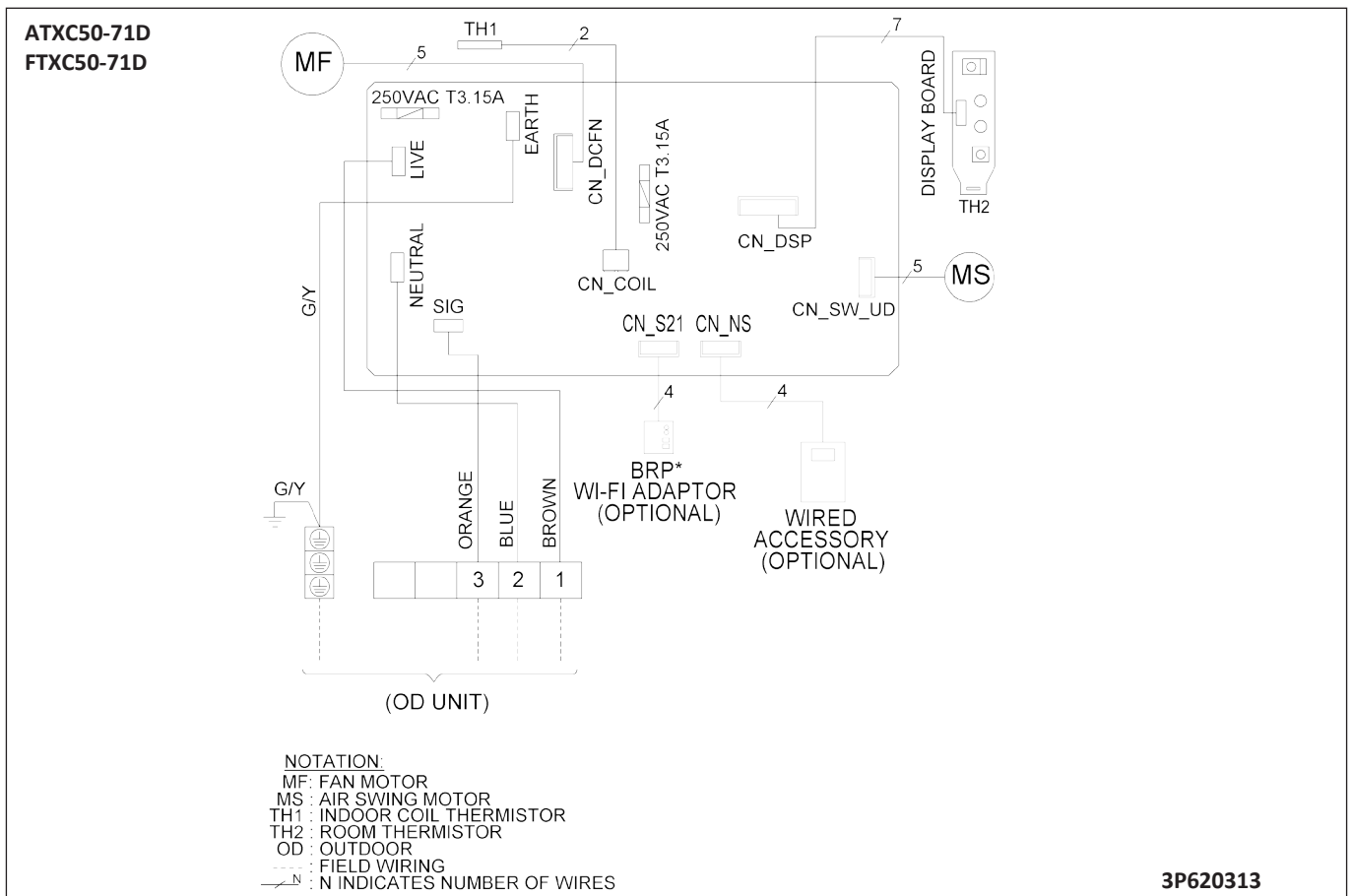
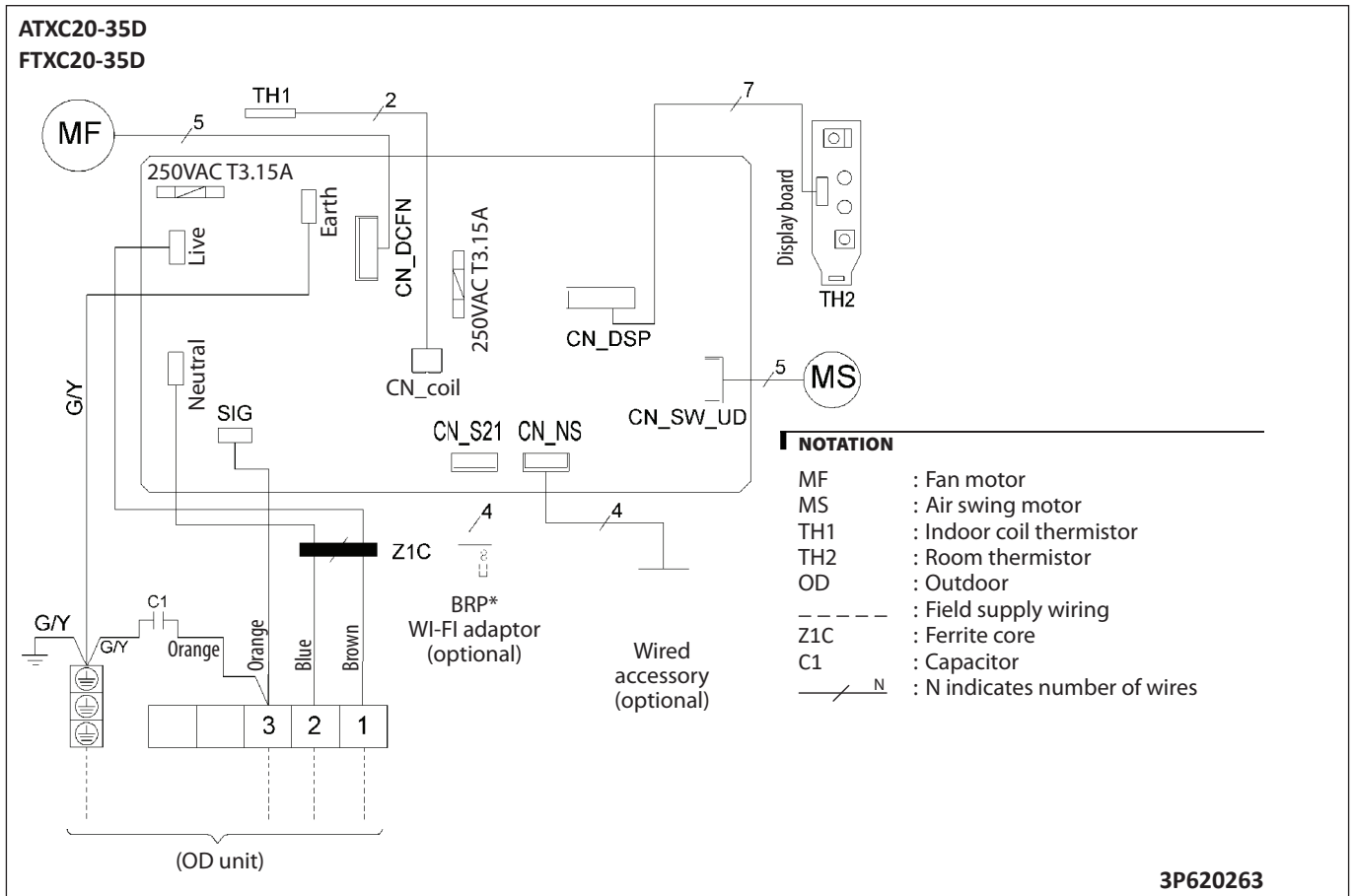

# 6 Sound data

## 6 - 1 Sound Pressure Spectrum

6

ATXC20-25D / FTXC20-25D

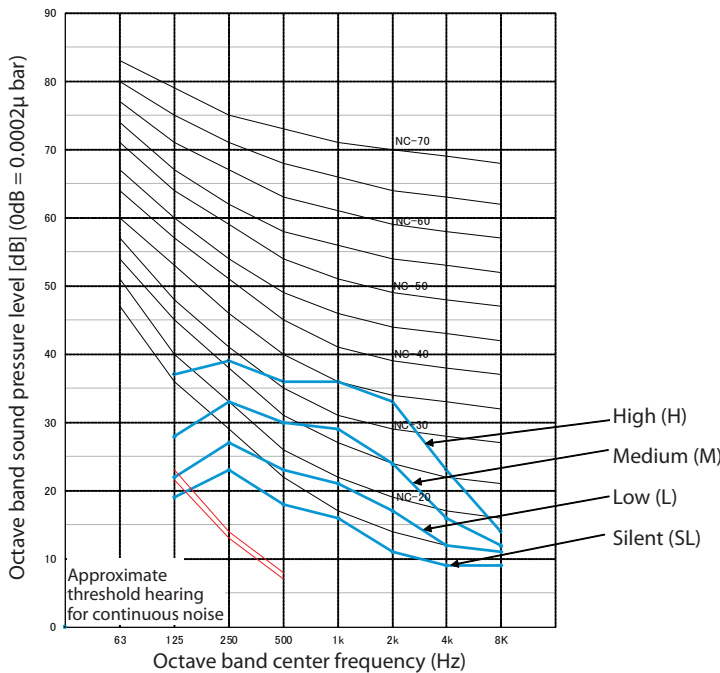

**NOTES**

1. Measuring place  
Anechoic chamber  
Operation noise differs with operation and ambient conditions.
2. Operating conditions  
Power source: 220-240V 50Hz
3. Location of microphone.

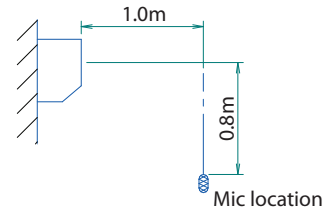

Testing Data Input								Overall (dBA)	Noise criteria
Fan speed	125	250	500	1k	2k	4k	8k		
H	37	39	36	36	33	23	14	40	35
M	28	33	30	29	24	16	12	33	28
L	22	27	23	21	17	12	11	26	19
SL	19	23	18	16	11	9	9	21	-

3D141720

ATXC35D / FTXC35D

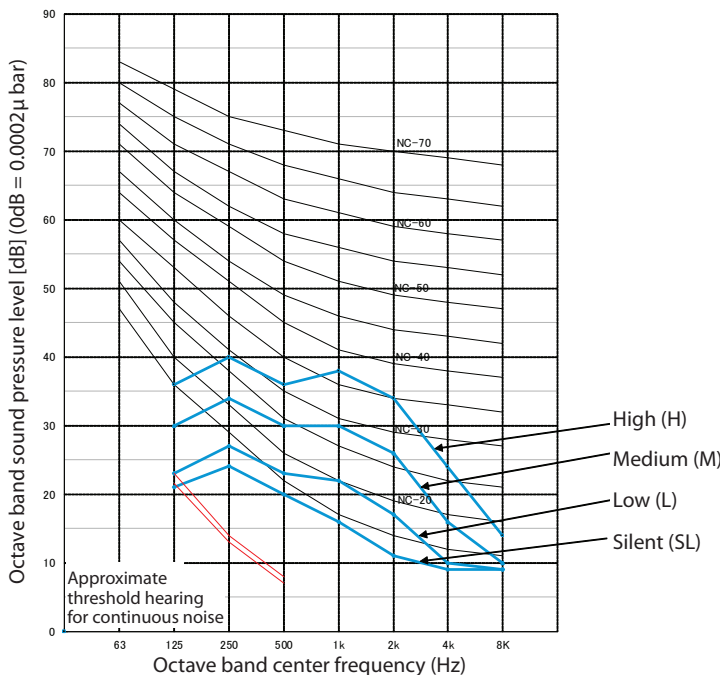

**NOTES**

1. Measuring place  
Anechoic chamber  
Operation noise differs with operation and ambient conditions.
2. Operating conditions  
Power source: 220-240V 50Hz
3. Location of microphone.

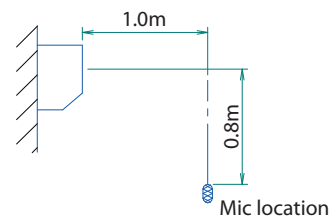

Testing Data Input								Overall (dBA)	Noise criteria
Fan speed	125	250	500	1k	2k	4k	8k		
H	36	40	36	38	34	24	14	41	37
M	30	34	30	30	26	16	10	34	29
L	23	27	23	22	17	10	9	26	20
SL	21	24	20	16	11	9	9	22	-

3D141719

# 6 Sound data

## 6 - 1 Sound Pressure Spectrum

### ATXC50D / FTXC50D

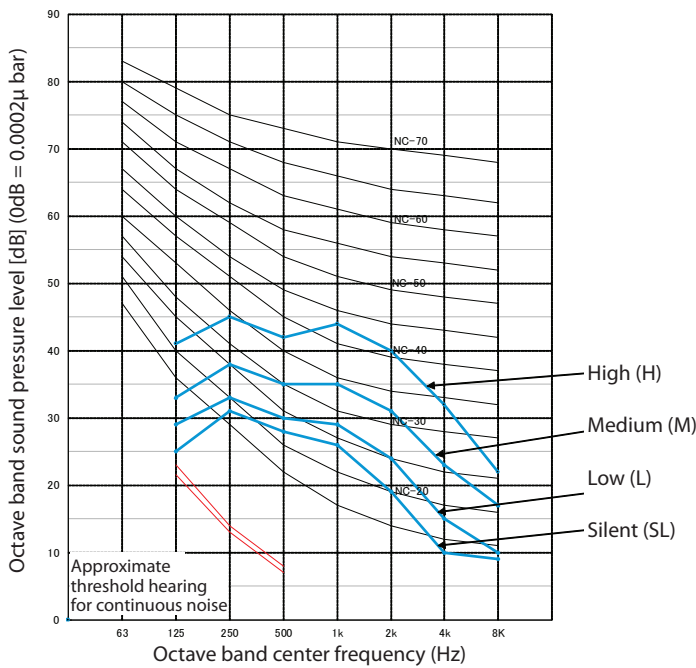

#### NOTES

1. Measuring place  
Anechoic chamber  
Operation noise differs with operation and ambient conditions.
2. Operating conditions  
Power source: 220-240V 50Hz
3. Location of microphone.

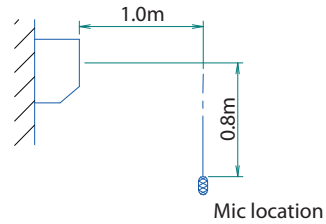

Testing Data Input								Overall (dBA)	Noise criteria
Fan speed	125	250	500	1k	2k	4k	8k		
H	41	45	42	44	40	32	22	47	43
M	33	38	35	35	31	23	17	39	34
L	29	33	30	29	24	15	10	33	28
SL	25	31	28	26	19	10	9	30	24

3D141721

### FTXC60-71D / ATXC60-71D

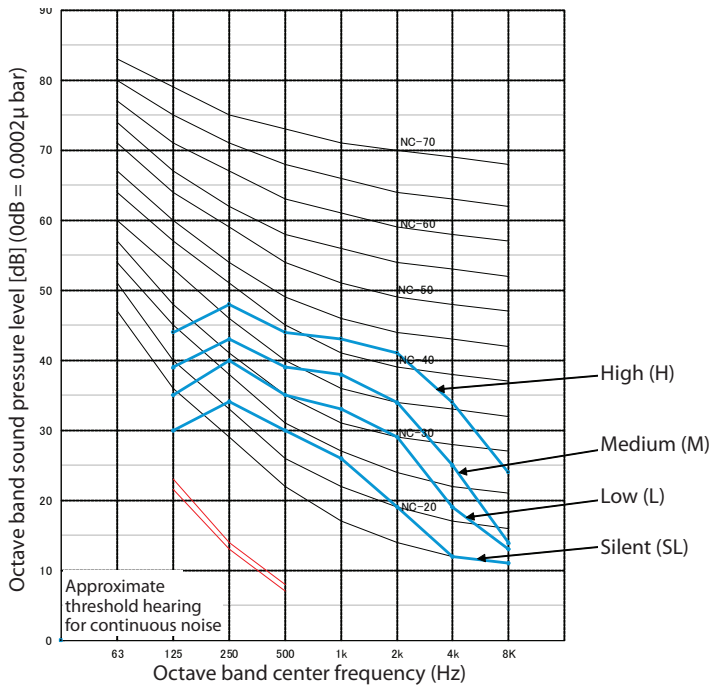

#### NOTES

1. Measuring place  
Anechoic chamber  
Operation noise differs with operation and ambient conditions.
2. Operating conditions  
Power source: 220-240V 50Hz
3. Location of microphone.

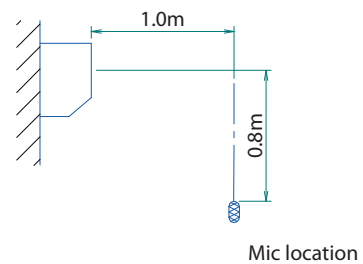

Testing Data Input								Overall (dBA)	Noise criteria
Fan speed	125	250	500	1k	2k	4k	8k		
H	44	48	44	43	41	34	24	48	42
M	39	43	39	38	34	25	14	42	37
L	35	40	35	33	29	19	13	38	32
SL	30	34	30	26	19	12	11	31	24

3D141723

---

**Daikin Europe N.V.** Naamloze Vennootschap · Zandvoordestraat 300 · 8400 Oostende · Belgium · [www.daikin.eu](http://www.daikin.eu) · BE 0412 120 336 · RPR Oostende (Responsible Editor)

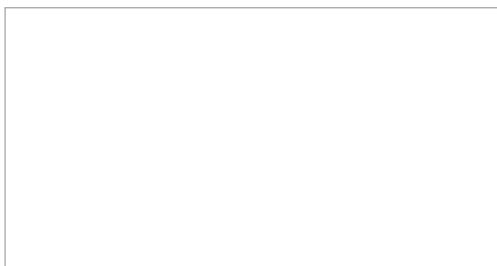

Daikin Europe N.V. participates in the ECP programmes for Fan Coil Units and Variable Refrigerant Flow systems. Daikin Applied Europe S.p.A. participates in the ECP programmes for Liquid Chilling Packages and Hydronic Heat Pumps. Check ongoing validity of certificate: [www.eurovent-certification.com](http://www.eurovent-certification.com)

EEDEN22

10/2022



The present leaflet is drawn up by way of information only and does not constitute an offer binding upon Daikin Europe N.V. Daikin Europe N.V. has compiled the content of this leaflet to the best of its knowledge. No express or implied warranty is given for the completeness, accuracy, reliability or fitness for particular purpose of its content and the products and services presented therein. Specifications are subject to change without prior notice. Daikin Europe N.V. explicitly rejects any liability for any direct or indirect damage, in the broadest sense, arising from or related to the use and/or interpretation of this leaflet. All content is copyrighted by Daikin Europe N.V.